

EL 125 E2M 01

rørventilator

VENTAS
VENTILATORER

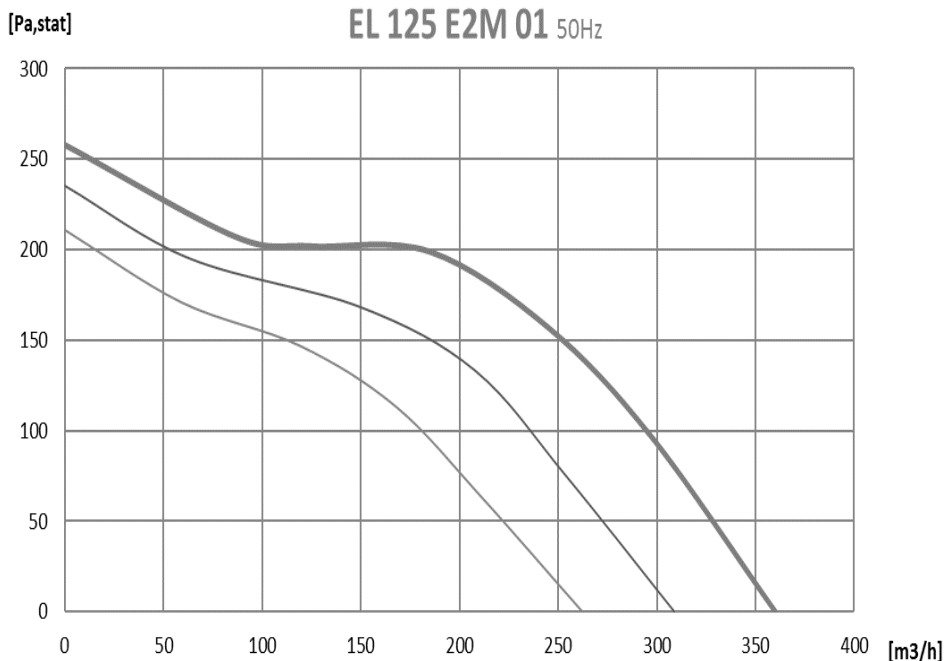

Spænding [V]	230
Frekvens [Hz]	50
Max. effekt [W]	52
Max. strøm [A]	0.2
Max. hastighed [rpm]	2840
Max. omgivelsestemperatur [°C]	80
Isolationsklasse	F
Vægt [Kg]	2.7
Max. luftmængde [m³/h]	360
Max. tryk [Pa]	260

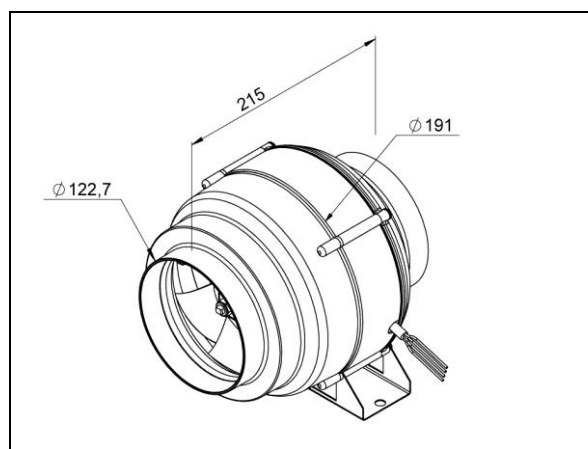

Diagonalhjul med ledeskovle	✓
Plasthus	✓
Integreret termokontakt	✓
Vedligeholdelsesfri kuglelejer	✓
3-hastighedsmotor	✓
Spændingsregulerbar	✓
Stort program af tilbehør	✓
CE mærket	✓

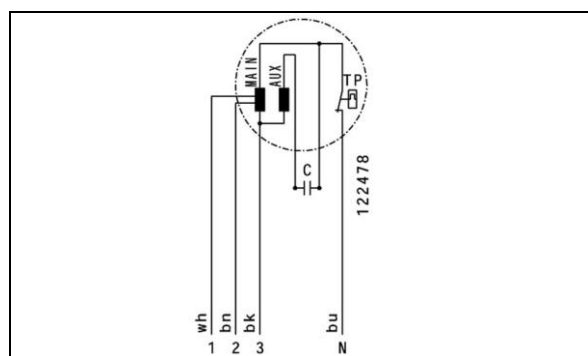

Der tages forbehold for trykfejl
Specifikationer kan ændres uden forudgående varsel - 2014/03